



Equilibrium ball float valve with balanced single seat - Mod. ATHENA

The ATHENA is a single seat upstream pressure balanced equilibrium ball float valve, which automatically controls the constant level of a tank or reservoir, regardless of upstream pressure variations, and shuts off when the maximum level is reached. Thanks to its exclusive technology ATHENA brings the concept of reliability and performance to the highest standards.



Technical features and benefits

- Body in ductile cast iron with three ways, allowing the installation both with an angle or a globe pattern, containing an interchangeable sealing seat and piston in stainless steel and a guiding bush in bronze.
- Mobile block composed of the main shaft, obturator, gasket retainer and piston featuring a unique self-cleaning technology (pat. pending) to reduce the accumulation of dirt and maintenance operations.
- The lever mechanism, in zinc-plated or stainless steel, is obtained from a double rod (single rod for DN 40/50/65) which, by means of pivots, puts the shaft in communication with the float which imparts the movement allowing the opening or closing of the valve.
- A large float in stainless steel AISI 304/316 is connected to the lever mechanism by means of a stainless steel pipe, onto which it exerts a vertical force.
- The valves modulates and throttle the inflow proportionally to the consumption, accuracy and perfect water-tightness is guaranteed also with low pressure values.
- Thanks to the upstream pressure balanced seat the movement of the obturator and valve performance is not affected by upstream pressure fluctuations, transient and unwanted surges are therefore avoided.

Applications

- Water distribution systems.
- Fire protection storage tanks.
- Irrigation systems.
- Whenever the constant level regulation and control function is required.

Operating principle - Angle pattern installation

Athena ball float valve is the best solution for a constant maximum level control balancing the inflow and outflow demand. Driven by a large float in stainless steel the valve closes drip-tight at the maximum level, and modulates to maintain it as soon as it drops due to consumptions.

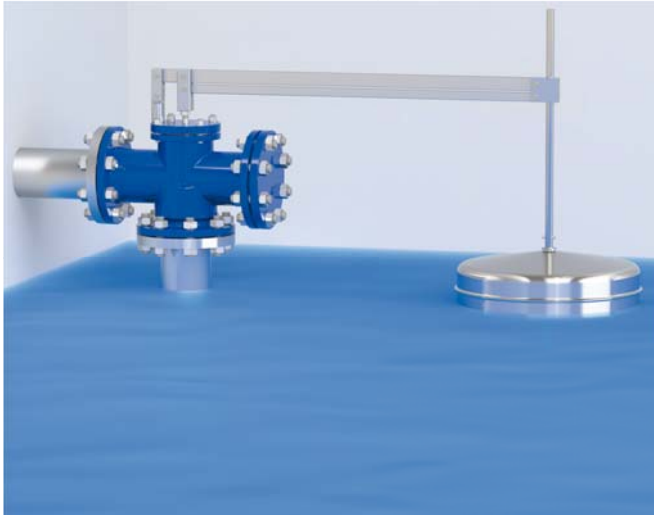

Closed valve

When water level reaches the maximum operating point levers are perfectly horizontally aligned and the valve closes thanks to the upward force exerted by the float.

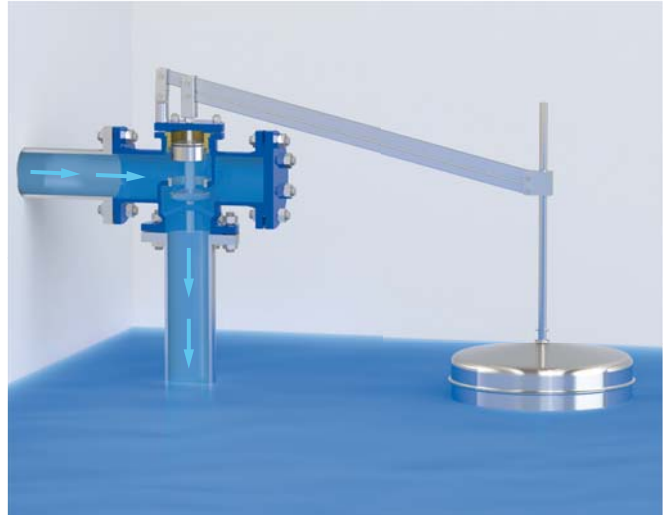

Opened valve

As the reservoir level drops the valve opens proportionally through the levers, receiving a downward force from the float, to increase the filling rate.

Globe pattern installation

The three ways body of Athena allows both the installations an angle and globe pattern, simply by placing the blank flange to the desired outlet. The lever mechanism is normally aligned with the valve axis. It is possible to rotate it on site, with an angle of 45°/90°, to fit the installation requirements.

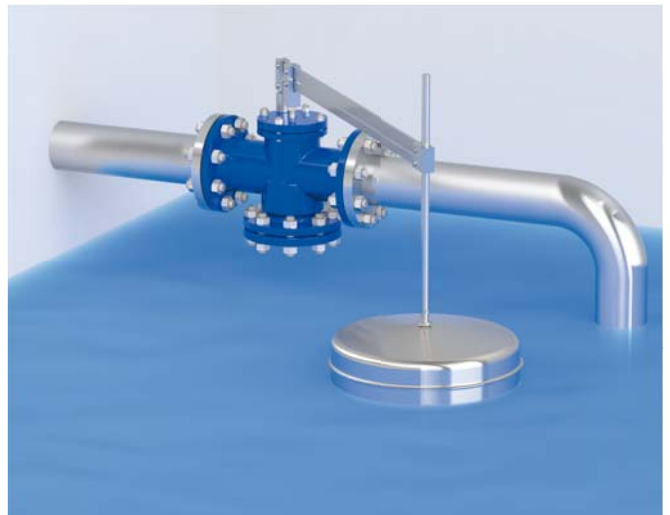
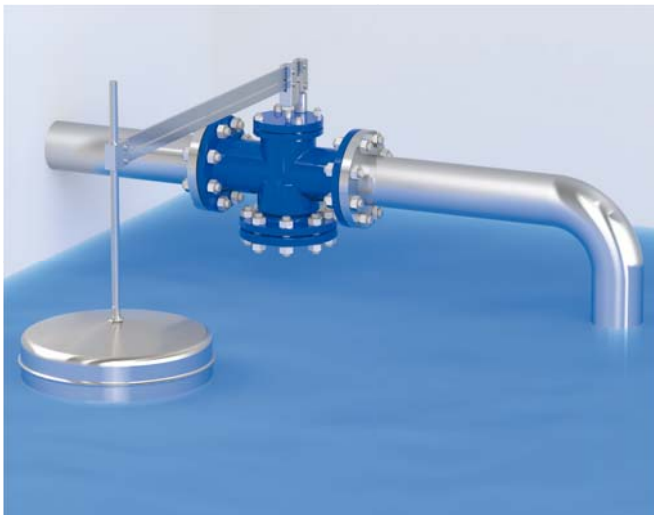

Optional



■ **Anti freezing device.** On request the valve is provided with a 3/8" G threaded outlet, which can be used as an anti-freezing device, simply by replacing the tap with a drainage ball valve discharging directly into the tank.

During the winter season, when the temperature drops consistently, the partial opening of the drainage port will create a flow circulation avoiding frost and possible damages related to it.

Technical data

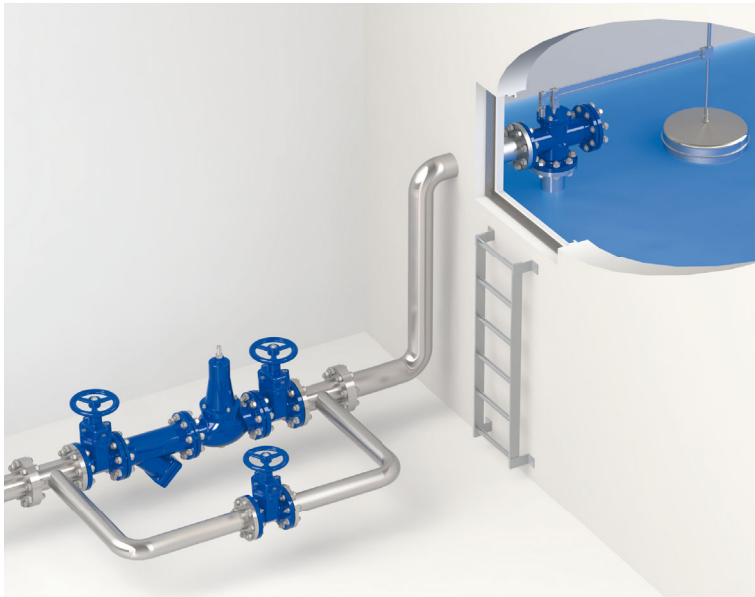

Installation

- Make sure that the supply pipe has the flanges drilled according to the requested PN and that ATHENA is installed horizontally, properly fixed and sustained.
- Gate valves and filters have to be installed to allow for maintenance operations, and to prevent dirt from reaching the internal components of the valve.
- Position the valve in a place which is easy to reach and wide enough for maintenance and control purposes.
- Observe the overflow level and make sure that the outlet flange remains always above it, this is to avoid back-flow.
- In case of excessive Δp , to avoid cavitation and possible damages to the valve, a direct acting pressure reducing valve CSA VRCD series should be installed.

Working conditions

Fluid: treated water.
 Maximum temperature: 70°C.
 Maximum pressure: 16 bar; contact CSA for higher values.

Standard

Certified and tested in compliance with EN-1074/5.
 Flanges according to EN 1092/2.
 Epoxy painting applied through fluidized bed technology blue RAL 5005. Variations on flanges and painting on request.

DN mm	40	50	65	80	100	125	150	200	250	300
Kv (m ³ /h)/bar	21,6	21,6	46,8	68,4	108	155	245	360	648	1008

DN mm	40	50	65	80	100	125	150	200	250	300
Kv (m ³ /h)/bar	18,4	18,4	39,6	59,4	90	133	209	313	576	864

Head loss coefficient for angle pattern

Kv coefficient representing the flow rate flowing through the valve fully open, and producing a head loss of 1 bar.

Head loss coefficient for globe pattern

Kv coefficient representing the flow rate flowing through the valve fully open, and producing a head loss of 1 bar.

Weights and dimensions

DN mm	A mm	B mm	C mm	D mm	L mm	H mm	R mm	h mm	E mm	Wt Kg
40	230	82,5	173	165	600	Ø220		105	525	21
50	230	82,5	173	165	600	Ø220		105	525	21
65	290	92,5	193	185	600	Ø220		180	525	26
80	310	100	235	200	800	200	300	210	600	33
100	350	125	233	220	800	180	400	267	600	41
125	400	125	238	250	800	180	400	267	600	49
150	480	162	371	285	1000	250	400	400	540	79
200	600	183	420	340	1000	250	400	418	540	118
250	730	270	540	405	1220	300	500	510	945	215
300	850	300	610	460	1400	400	500	610	1042	250

All values are approximate, consult CSA service for more details.

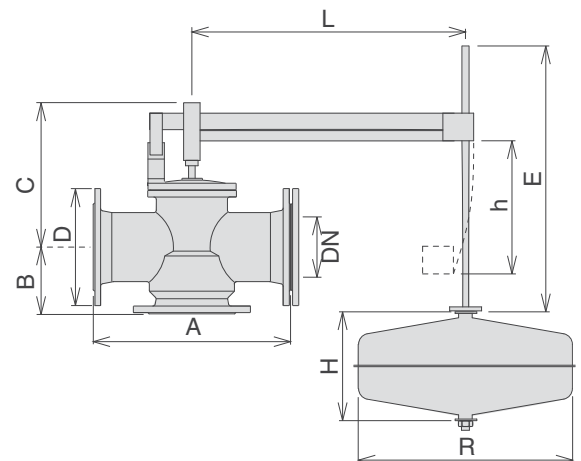

Technical details

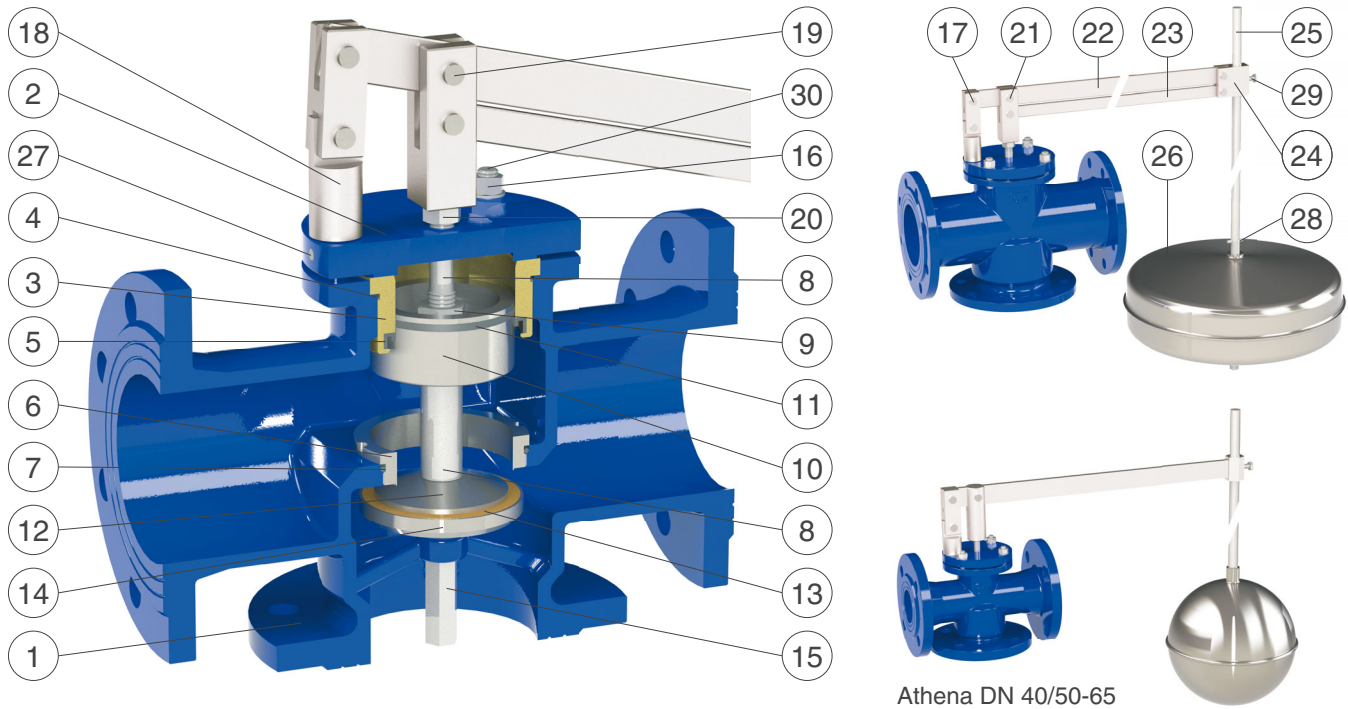

Athena DN 40/50-65

N.	Component	Standard material	Optional
1	Body	ductile cast iron GJS 450-10	
2	Cap	painted steel	
3	Guiding bushing	bronze CuSn5Zn5Pb5 (painted steel for DN 250-300)	stainless s. AISI 304/316
4	O-ring	NBR	EPDM/Viton
5	Lip gasket	NBR	EPDM/Viton
6	Seat	stainless steel AISI 304	stainless steel AISI 316
7	O-ring	NBR	EPDM/Viton
8	Guiding shaft	stainless steel AISI 303	stainless steel AISI 316
9	Blocking nut	stainless steel AISI 304	stainless steel AISI 316
10	Piston	stainless steel AISI 303	stainless steel AISI 316
11	Guiding ring	PTFE	
12	Counter-seat	stainless s. AISI 303 (painted steel for DN 250-300)	stainless s. AISI 304/316
13	Plane gasket	NBR	polyurethane
14	Obturator	stainless s. AISI 303 (AISI 304 for DN 200-250-300)	stainless steel AISI 316
15	Tightening nut	stainless steel AISI 303	stainless steel AISI 316
16	Nuts (or screws) and washers	stainless steel AISI 304	stainless steel AISI 316
17	Upper coupling	zinc-plated steel	stainless s. AISI 304/316
18	Lower coupling	zinc-plated steel	stainless s. AISI 304/316
19	Pivots	stainless steel AISI 303	stainless steel AISI 316
20	Blocking nut	stainless steel AISI 304	stainless steel AISI 316
21	Shaft pivot	zinc-plated steel	stainless s. AISI 304/316
22	Upper lever	zinc-plated steel	stainless s. AISI 304/316
23	Lower lever (from DN 80)	zinc-plated steel	stainless s. AISI 304/316
24	Float coupling (from DN 80)	zinc-plated steel	stainless s. AISI 304/316
25	Float rod	stainless steel AISI 304	stainless steel AISI 316
26	Float	stainless steel AISI 304	stainless steel AISI 316
27	Plug (screw from DN 150 to 300)	stainless steel AISI 304	stainless steel AISI 316
28	Elastic pin (from DN 80)	stainless steel AISI 304	
29	Screw	stainless steel AISI 304	stainless steel AISI 316
30	Studs (from DN 150 to 300)	stainless steel AISI 304	stainless steel AISI 316

Spare parts breakdown

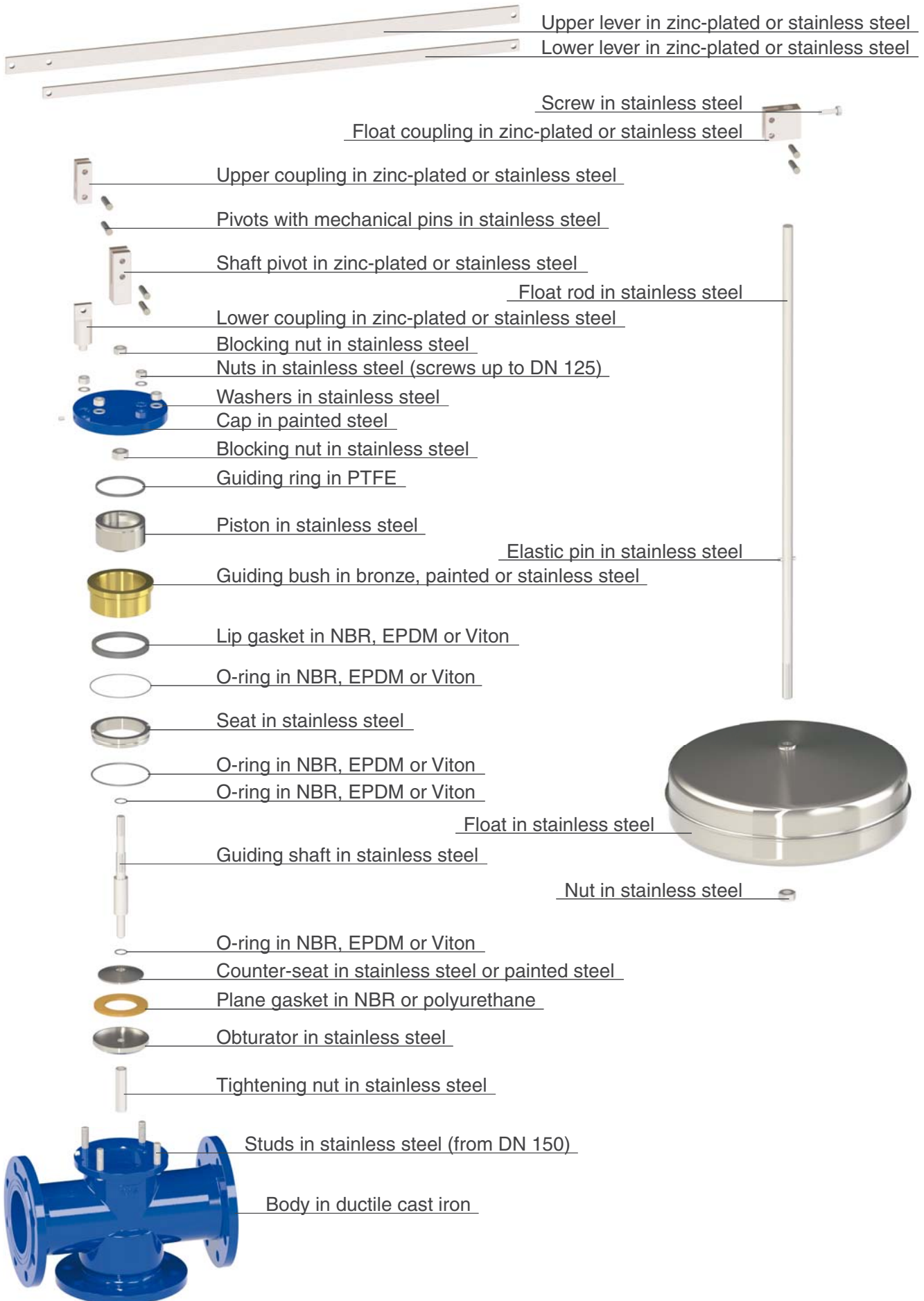



Kv to valve opening chart

The following chart shows the opening percentage of Athena valves versus the Kv.

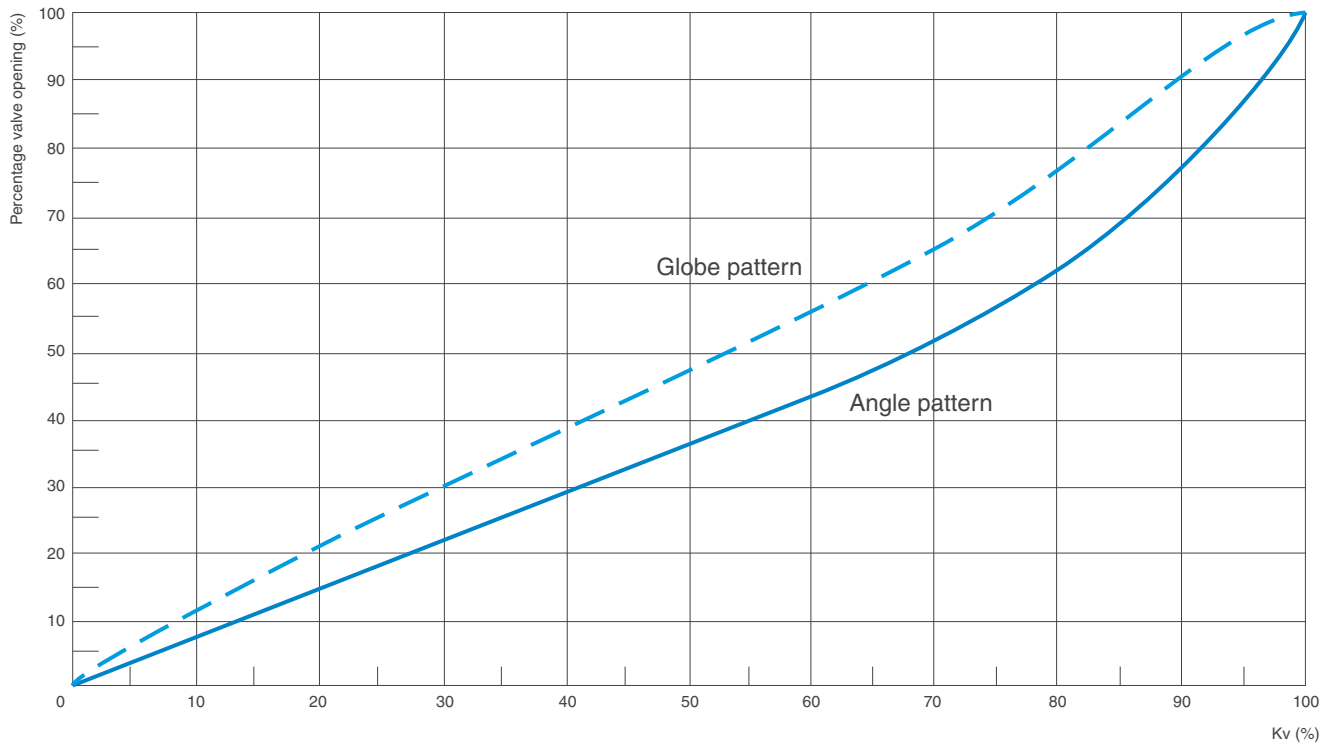

Recommended flow rate

The following chart shows the recommended flow rate for the proper sizing of Athena valves.

Athena - angle pattern

DN (mm)	40/50	65	80	100	125	150	200	250	300
Flow rate min. (l/s)	0,3	0,5	0,8	1,2	1,9	2,7	4,8	7,4	11
Flow rate max. (l/s)	6,4	10	16	25	40	58	103	161	233
Emergency (l/s)	7,8	13	20	31	49	70	125	196	282

Athena - globe pattern

DN (mm)	40/50	65	80	100	125	150	200	250	300
Flow rate min. (l/s)	0,4	0,7	1,1	1,6	2,5	3,6	6,3	9,9	15
Flow rate max. (l/s)	5,1	8,6	13	20	31	45	81	127	183
Emergency (l/s)	6,4	10	16	25	40	58	103	161	233

Velocity chart to opening - Angle pattern

The following chart shows the maximum recommended velocity, versus opening percentage, to avoid cavitation.

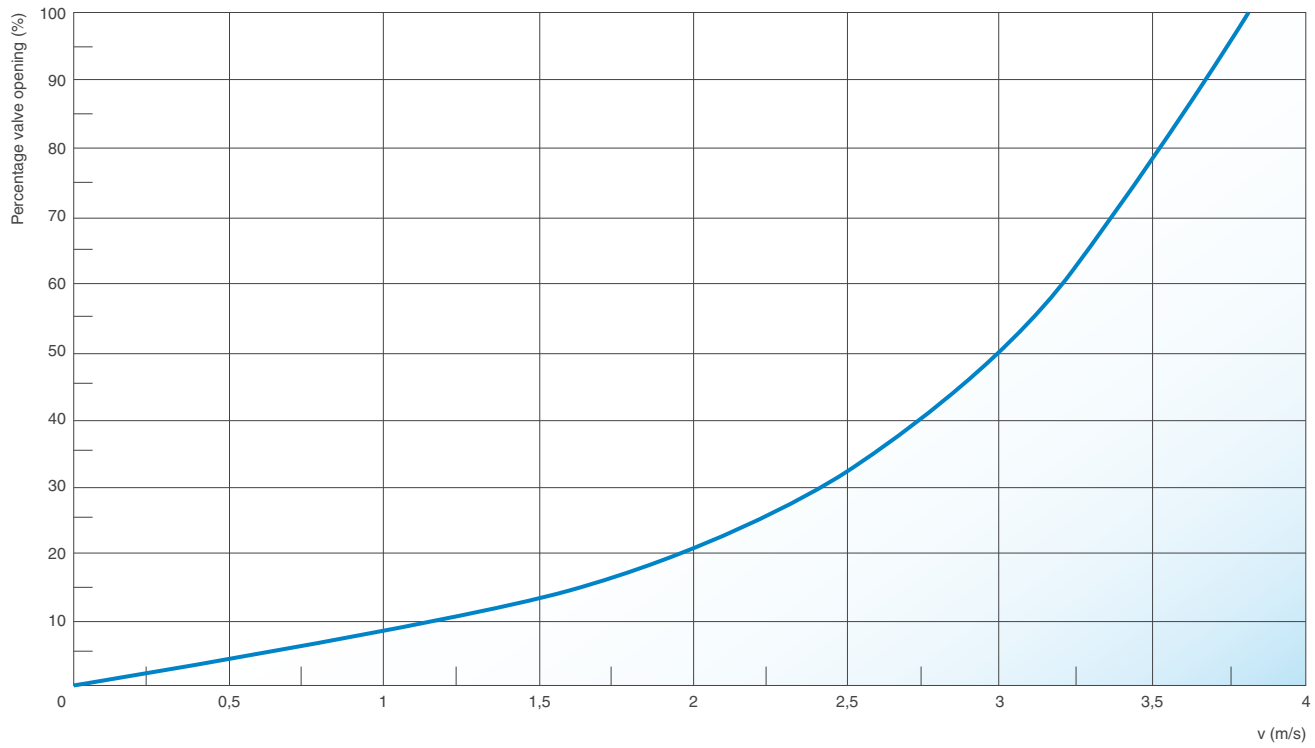

Velocity chart to opening - Globe pattern

The following chart shows the maximum recommended velocity, versus opening percentage, to avoid cavitation.

